

Uputstvo za ugradnju prihvatnika za mikroventilaciju–okretno-nagibno otvaranje
 Installation instruction for the micro-ventilation acceptance part (frame counter)-Tilt and turn opening
 Монтаж запорной планки для функции микровентиляции–для поворотно-наклонных створок



Primena:

Za sve sisteme aluminijumskih prozora i vrata sa standardnim euro žljebom za smeštaj okova.

Application:

For all window and door aluminium systems with a standard euro-groove for hardware installation.

Применение:

Для запирания поворотных и поворотно-наклонных створок из алюминиевого профиля с евро-пазом.

SR / Tehničke informacije:

- Nosač prihvatnika i prihvatnik od legure cinka.
- Zavrtnji od nerđajućeg celika.

EN / Technical information:

- Carrier and acceptance part made of zinc alloy
- Stainless steel screws.

RU / Техническая информация:

- Держатель запорной планки и запорная планка изготовлены из цинкового сплава.
- Винты из нержавеющей стали.



4010.60

4010.60

RW

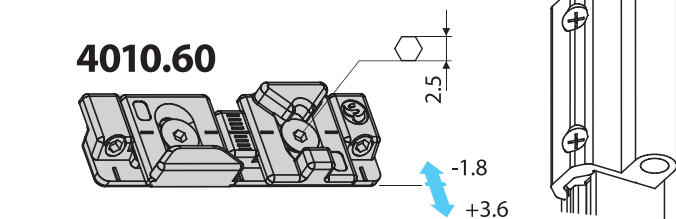

LW

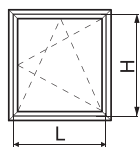
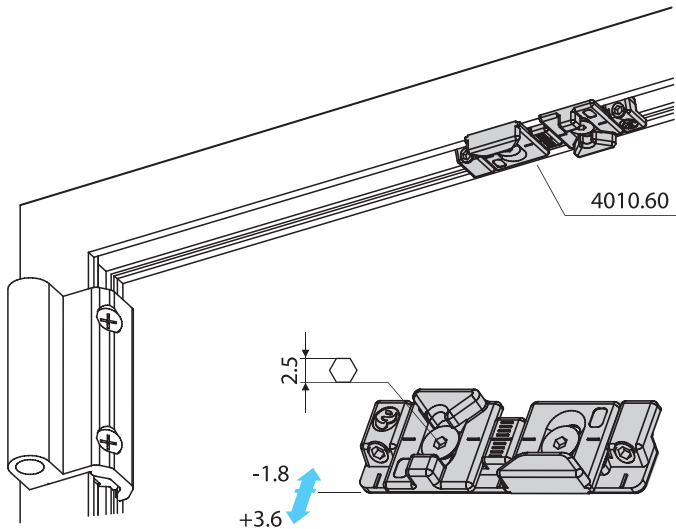

H=465-2400 L=535-1200 **4030.02**

H=465-2400 L=445-535 **4030.01**

H=465-2400 L=1200-1400 **4030.05**

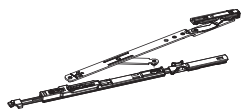

H=600-2400 L=584-1600 **4115.18R(L)**

H=600-2400 L=505-583 **4116.18R(L)**

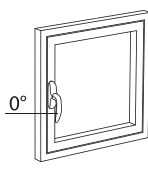
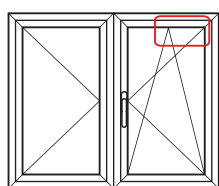
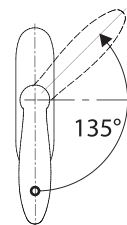
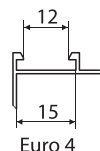
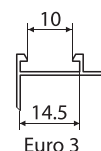
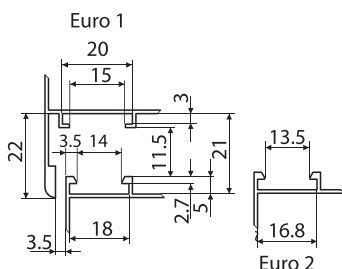

Zatvoreno
Closed
Закрыто

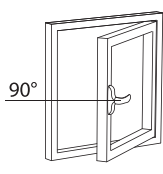

Otvoreno
Openly
Открыто

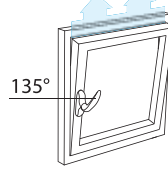
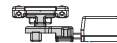

Mikroventilacija
Micro-ventilation
Микровентиляция

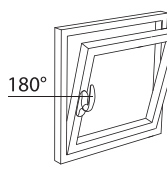

Nagib
Tilt
Наклон