

Spojnice

Hinges

Петли



2022.00

SR / Tehničke informacije:

- Proizvedeno od aluminijumskih profila.
- Pločice pribora i zavrtnji od nerđajućeg čelika.
- Plastični delovi su od poliamida.
- Završna obrada, praškasta i tečna prevlaka.

EN / Technical information:

- Manufactured aluminium profiles.
- Accessories counterplates and screws are made out of stainless steel.
- Plastic parts are made of polyamide.
- Surface protection powder coating and liquid painting.

RU / Техническая информация:

- Изготовлена из алюминиевого профиля.
- Крепежные планки и винты из нержавеющей стали.
- Детали прибора из полиамида.
- Окончательная обработка, порошковая и жидкая краска.

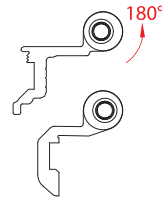
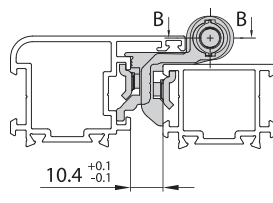

Presek B-B

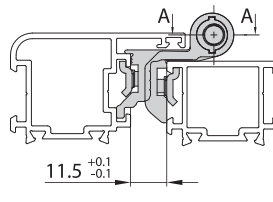
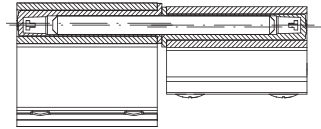

Presek A-A

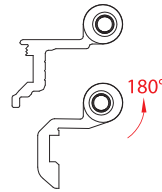
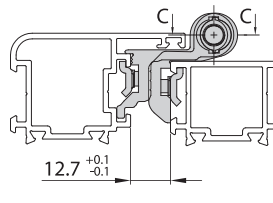
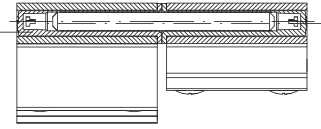

Presek C-C

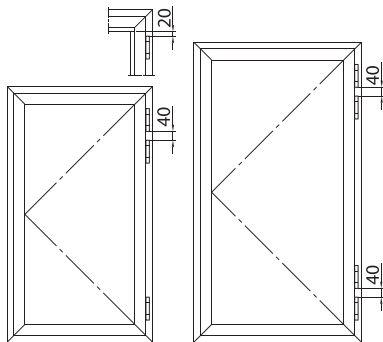
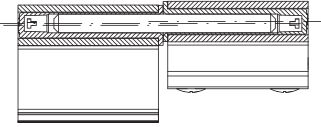

2022.00P

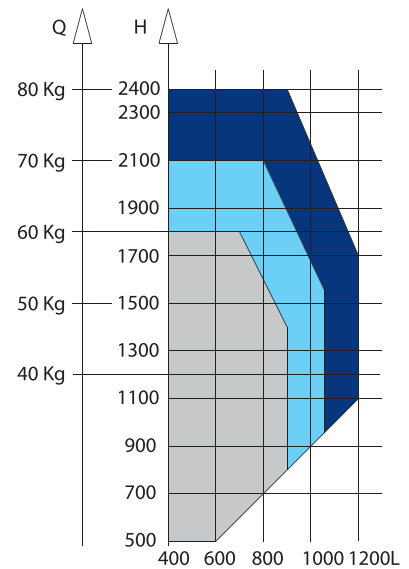
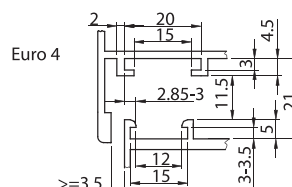
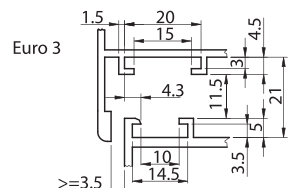
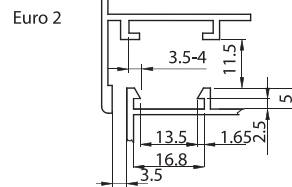
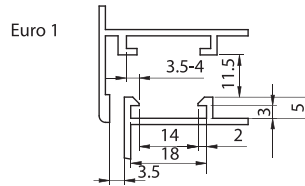
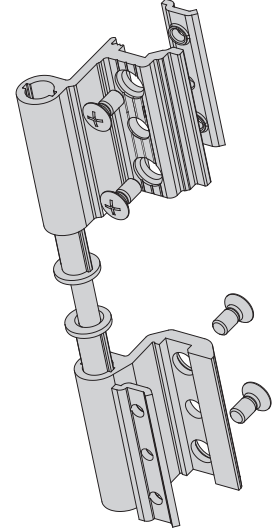
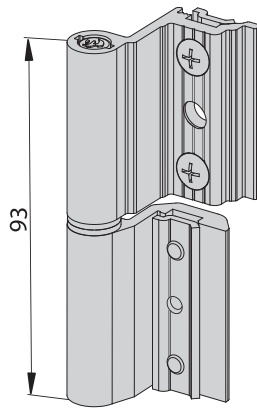
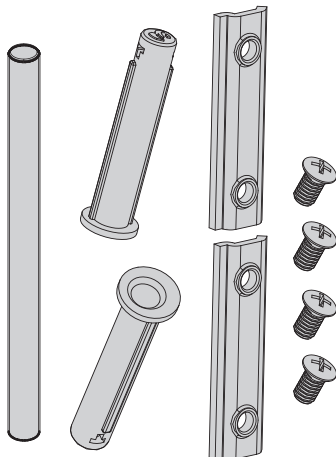

4 spojnice
3 spojnice
2 spojnice